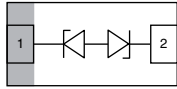

Single-Line Bidirectional ESD-Protection Diode in DFN1006-2B

MARKING (example only)

Bar = pin 1 marking

X = date code

YY = type code (see table below)

LINKS TO ADDITIONAL RESOURCES

FEATURES

- Compact DFN1006-2B package
- Low package height < 0.5 mm
- 1-line bidirectional ESD-protection
- AEC-Q101 qualified available
- OPEN Alliance 100Base-T1 and 1000Base-T1 compliant
- Working range ± 24 V
- Trigger voltage >100 V
- Capacitance < 2 pF
- ESD immunity acc. ISO 10605 and IEC 61000-4-2 (150 pF/330 Ω) ± 15 kV (1000 x contact discharge)
- Lead plating: Sn (e3)
 - Including wettable side walls (flanks)
 - Soldering can be checked by standard vision inspection
 - AOI = automated optical inspection
- Material categorization: for definitions of compliance please see www.vishay.com/doc?99912



ORDERING INFORMATION							
PART NUMBER (EXAMPLE)	ENVIRONMENTAL AND QUALITY CODE				PACKAGING CODE		ORDERING CODE (EXAMPLE)
	AEC-Q101 QUALIFIED	RoHS-COMPLIANT + LEAD (Pb)-FREE TERMINATIONS	TIN PLATED	REV.	10K PER 7" REEL (8 mm TAPE)		
		GREEN			10K = MOQ		
VETH100A1DD1	-	G	3	-	08		VETH100A1DD1-G3-08
VETH100A1DD1	H	G	3	-	08		VETH100A1DD1HG3-08

PACKAGE DATA						
DEVICE NAME	PACKAGE NAME	TYPE CODE	WEIGHT	MOLDING COMPOUND FLAMMABILITY RATING	MOISTURE SENSITIVITY LEVEL	SOLDERING CONDITIONS
VETH100A1DD1	DFN1006-2B	2S	0.83 mg	UL 94 V-0	MSL level 1 (according J-STD-020)	Peak temperature max. 260 °C

ABSOLUTE MAXIMUM RATINGS ($T_{amb} = 25$ °C, unless otherwise specified)					
PARAMETER	TEST CONDITIONS		SYMBOL	VALUE	UNIT
ESD immunity	Contact discharge acc. ISO 10605 and IEC 61000-4-2 (150 pF/330 Ω); 1000 pulses		V_{ESD}	15	kV
Operating temperature	Junction temperature		T_J	-55 to +150	°C
Storage temperature			T_{stg}	-55 to +150	°C

ELECTRICAL CHARACTERISTICS ($T_{amb} = 25$ °C, unless otherwise specified)							
PARAMETER	TEST CONDITIONS / REMARKS		SYMBOL	MIN.	TYP.	MAX.	UNIT
Protection paths	Number of lines which can be protected		$N_{channel}$	-	-	1	lines
Stand off voltage	Max. working voltage		V_{RWM}	-	-	24	V
Leakage current	At $V_R = 24$ V		I_R	-	0.001	0.1	μ A
Trigger voltage	Transmission line pulse (TLP) = 100 ns; $I_{TLP} = 1$ A		V_T	100	-	-	V
Clamping voltage	At $I_{TLP} = 1$ A, $t_p = 100$ ns (TLP)		V_C	26	31	-	V
	At $I_{TLP} = 10$ A, $t_p = 100$ ns (TLP)		V_C	-	34	-	V
Dynamic resistance	$t_p = 100$ ns (TLP)		r_{dyn}	-	0.4	-	Ω
Capacitance	At $V_R = 0$ V; $f = 1$ MHz; $V_{AC} \pm 10$ mV		C_D	-	1.7	2.0	pF
	At $V_R = 0$ V; $f = 1$ MHz; $V_{AC} \pm 1$ V		C_D	-	1.4	-	pF

TECHNICAL NOTE

The ESD protection diode VETH100A1DD1 is a one line, bidirectional ESD-protection diode made for Automotive EtherNet which meets the OPEN Alliance specifications [IEEE 100BASE-T1 EMC Test Specification for Suppression Devices](#) and [IEEE 1000BASE-T1 EMC Test Specification for Suppression Devices](#).

The OPEN Alliance specifications specify various tests with the ESD protection diode mounted on test boards simulating the real environment in Automotive Ethernet application.

The test reports include the device classification according to related test specification such as:

- Mixed mode S-parameter measurement
- Damage from ESD
- ESD discharge current measurement and
- Unwanted clamping effect at RF immunity tests

The test reports are available on request (mail to: ESDprotection@vishay.com)

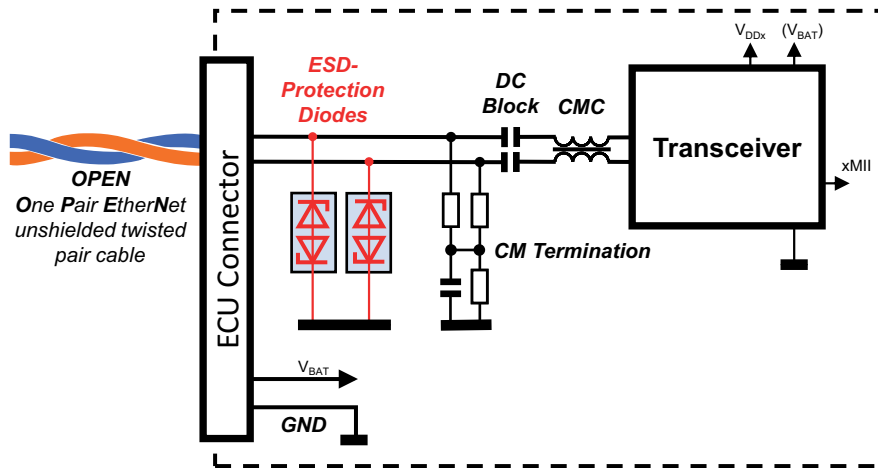

Connected between data line and ground the VETH100A1DD1 blocks voltages between -100 V and +100 V with low leakage current. Such high voltages can be induced in the unshielded twisted One Pair EtherNet (OPEN) cables by electromagnetic fields from anywhere in and around the vehicle where the in-vehicle-network is installed.

It needs a trigger voltage V_T above 100 V to trigger the voltage snap-back of the ESD-protection diode. In its snap-back state, the VETH100A1DD1 effectively clamps ESD pulses down to around 30 V (at $I_{TLP} = 1$ A). Additionally with this low dynamic resistance r_{dyn} the clamping voltage is only slightly depending on the current flowing through the diode to ground.

The very low capacitance C_D makes the VETH100A1DD1 invisible for the data signals, so that the data rate on the Automotive EtherNet network will not be affected.

ORDERING INFORMATION TABLE

Device code	V	ETH	100	A	1	DD1
	①	②	③	④	⑤	⑥

- 1** - **V = Vishay**
- 2** - **ETH = ETHernet**
- 3** - **100 = Blocking voltage 100 V**
- 4** - **A = Version number**
- 5** - **1 = 1-line protection**
- 6** - **DD1 = DFN1006-2B package**

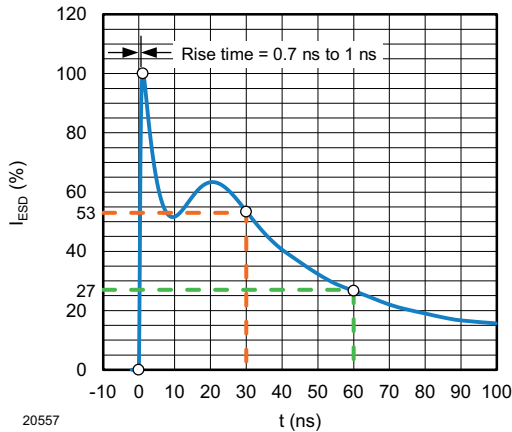

Fig. 1 - ESD Discharge Current Wave Form acc. IEC 61000-4-2 (330 Ω / 150 pF)

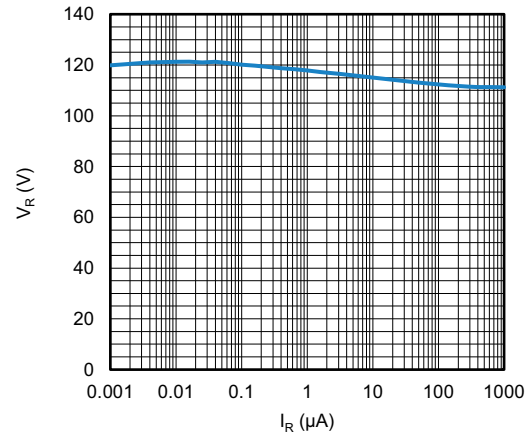

Fig. 4 - Typical Reverse Voltage vs. Reverse Current

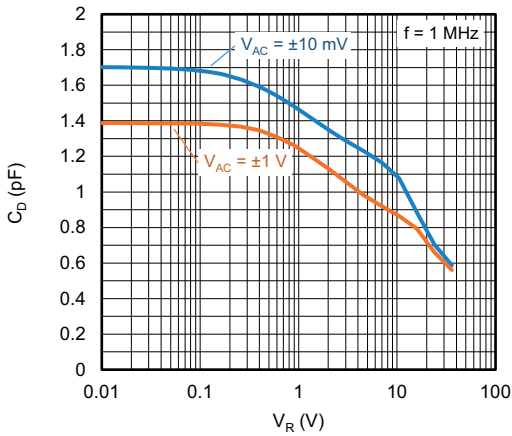

Fig. 2 - Typical Capacitance vs. Reverse Voltage

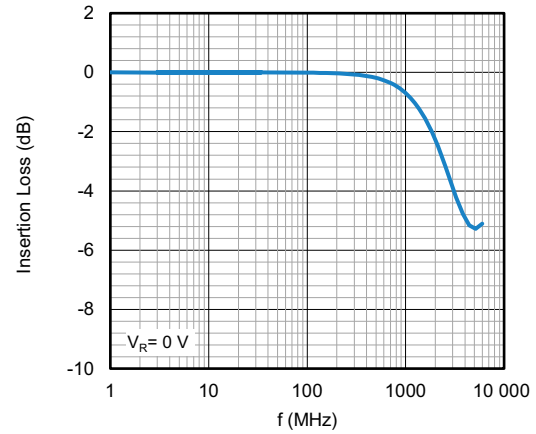

Fig. 5 - Typical Insertion Loss in a 50 Ω - System

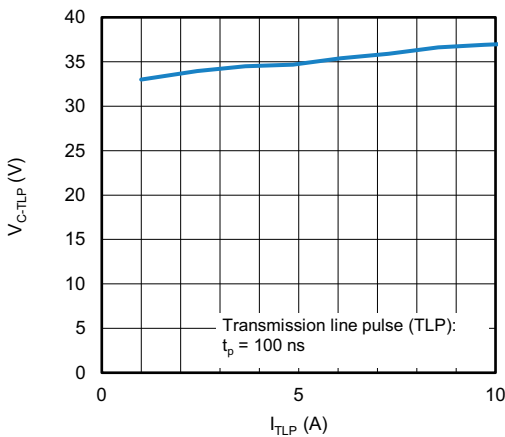

Fig. 3 - Typical Clamping Voltage vs. Peak Pulse Current

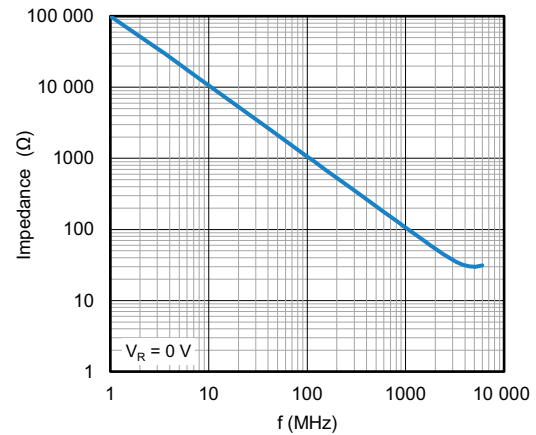
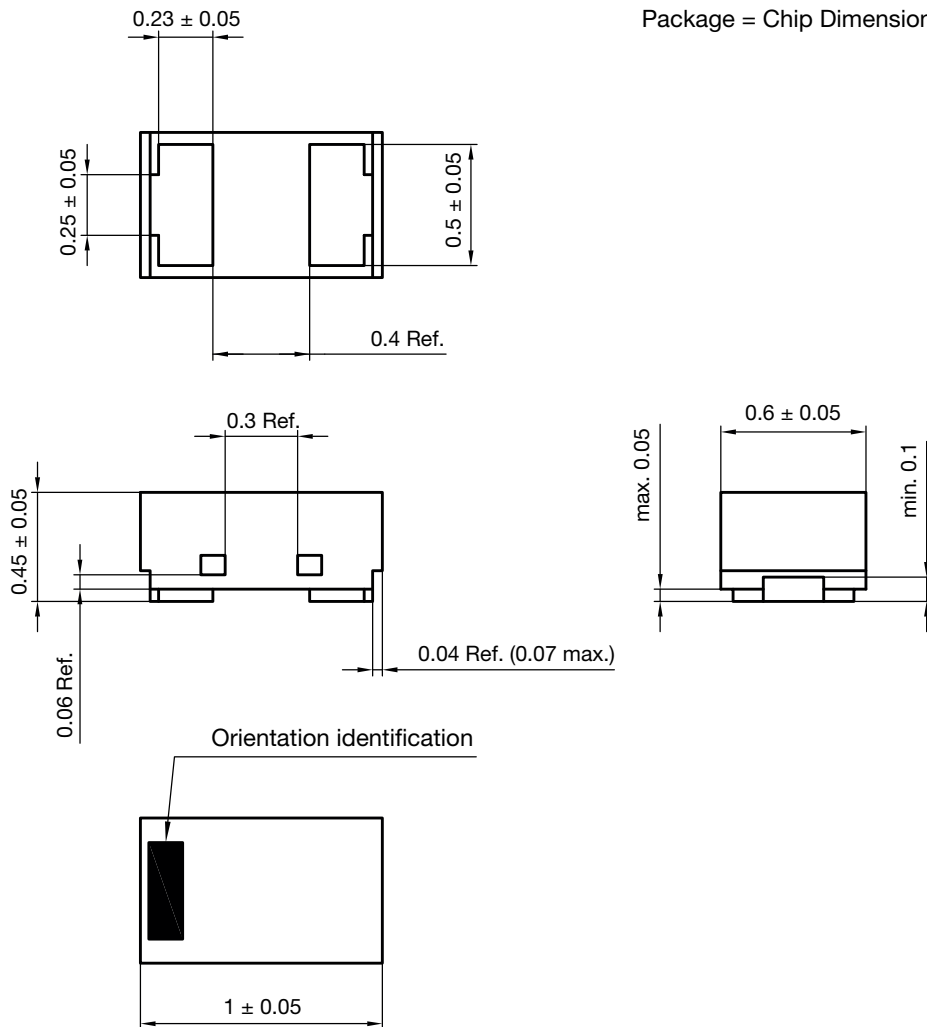

Fig. 6 - Typical Device Impedance vs. Frequency



PACKAGE DIMENSIONS in millimeters (inches): DFN1006-2B

Package = Chip Dimension in mm



Footprint recommendation

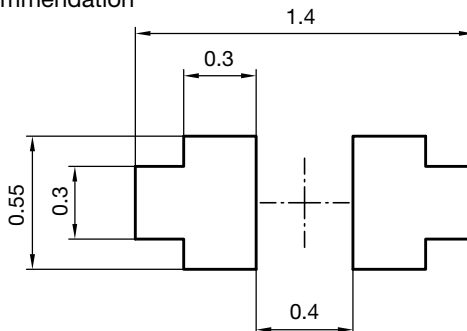

Document no.: S8-V-3906.04-059 (4)
Created - Date: 11-Jul-2018
Rev.5 - Date: 17-Sep-2021

23191

CARRIER TAPE DFN1006-2B

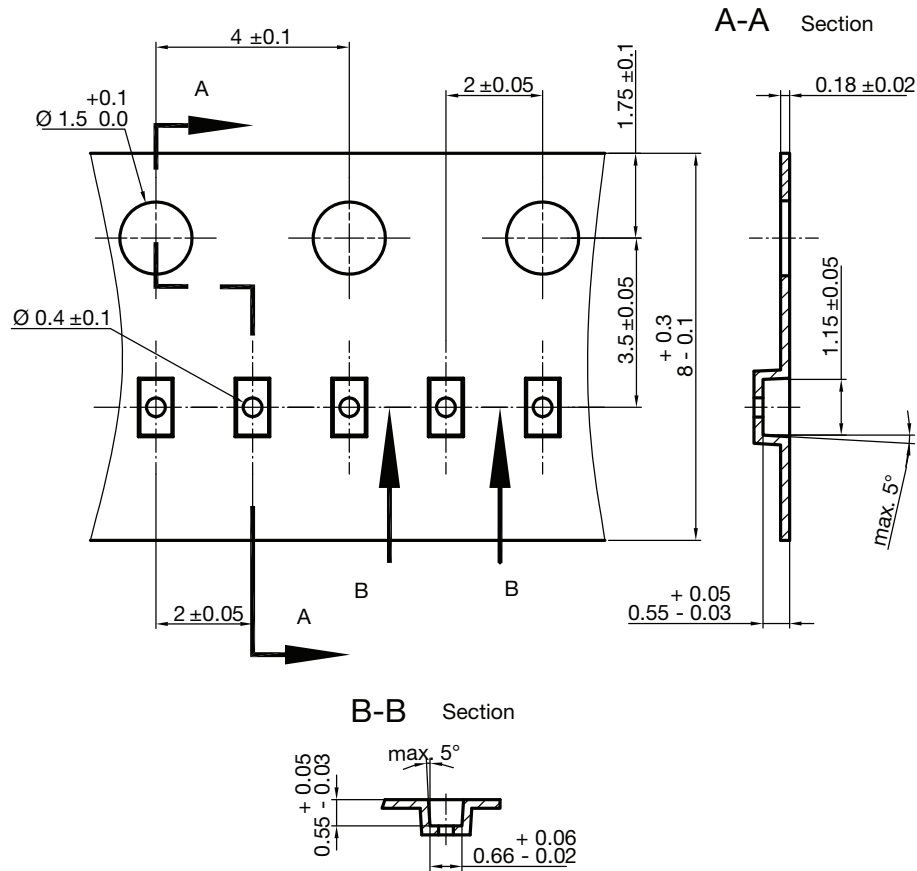

S8-V-3906.04-063 (4)
created 28.10.2019

surface resistance: $10^5 - 10^{11} \frac{\text{OHMS}}{\text{SQ}}$
Cumulative tolerances of 10 sprocket holes is ± 0.2 mm

ORIENTATION IN CARRIER TAPE DFN1006-2B

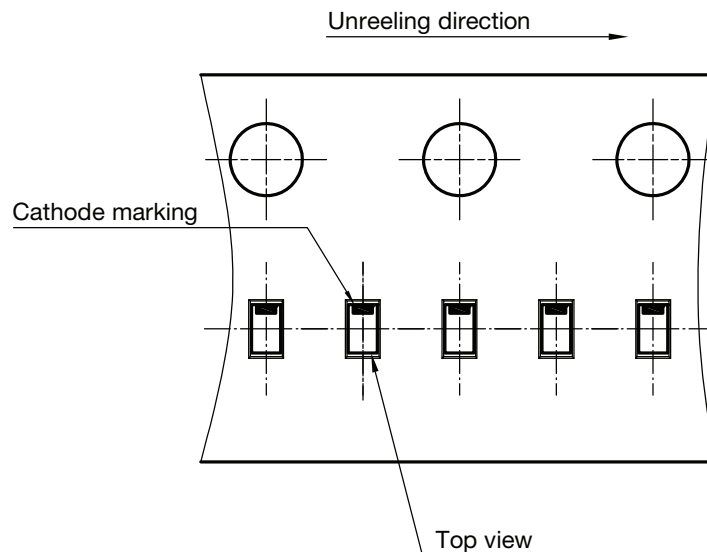

S8-V-3906.04-064 (4)
created 28.10.2019



Disclaimer

ALL PRODUCT, PRODUCT SPECIFICATIONS AND DATA ARE SUBJECT TO CHANGE WITHOUT NOTICE TO IMPROVE RELIABILITY, FUNCTION OR DESIGN OR OTHERWISE.

Vishay Intertechnology, Inc., its affiliates, agents, and employees, and all persons acting on its or their behalf (collectively, "Vishay"), disclaim any and all liability for any errors, inaccuracies or incompleteness contained in any datasheet or in any other disclosure relating to any product.

Vishay makes no warranty, representation or guarantee regarding the suitability of the products for any particular purpose or the continuing production of any product. To the maximum extent permitted by applicable law, Vishay disclaims (i) any and all liability arising out of the application or use of any product, (ii) any and all liability, including without limitation special, consequential or incidental damages, and (iii) any and all implied warranties, including warranties of fitness for particular purpose, non-infringement and merchantability.

Statements regarding the suitability of products for certain types of applications are based on Vishay's knowledge of typical requirements that are often placed on Vishay products in generic applications. Such statements are not binding statements about the suitability of products for a particular application. It is the customer's responsibility to validate that a particular product with the properties described in the product specification is suitable for use in a particular application. Parameters provided in datasheets and / or specifications may vary in different applications and performance may vary over time. All operating parameters, including typical parameters, must be validated for each customer application by the customer's technical experts. Product specifications do not expand or otherwise modify Vishay's terms and conditions of purchase, including but not limited to the warranty expressed therein.

Hyperlinks included in this datasheet may direct users to third-party websites. These links are provided as a convenience and for informational purposes only. Inclusion of these hyperlinks does not constitute an endorsement or an approval by Vishay of any of the products, services or opinions of the corporation, organization or individual associated with the third-party website. Vishay disclaims any and all liability and bears no responsibility for the accuracy, legality or content of the third-party website or for that of subsequent links.

Vishay products are not designed for use in life-saving or life-sustaining applications or any application in which the failure of the Vishay product could result in personal injury or death unless specifically qualified in writing by Vishay. Customers using or selling Vishay products not expressly indicated for use in such applications do so at their own risk. Please contact authorized Vishay personnel to obtain written terms and conditions regarding products designed for such applications.

No license, express or implied, by estoppel or otherwise, to any intellectual property rights is granted by this document or by any conduct of Vishay. Product names and markings noted herein may be trademarks of their respective owners.