

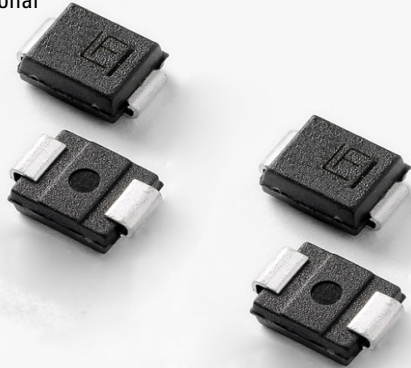

# SMBLCE-HR Series

## Surface Mount - 600W

Uni-directional



### Agency Approvals

Agency	Agency File/Certificate Number
	E230531

### Maximum Ratings & Thermal Characteristics

( $T_A=25^\circ\text{C}$  unless otherwise noted)

Parameter	Symbol	Value	Unit
Peak Pulse Power Dissipation ( $I_{PP} \times V_C$ ) at $T_L=25^\circ\text{C}$ by 10/1000 $\mu\text{s}$ Waveform (fig.1)( Note 1)	$P_{PPM}$	600	W
Power Dissipation on Infinite Heat Sink at $T_L=50^\circ\text{C}$	$P_D$	3.0	W
Operating Temperature Range	$T_J$	-65 to 150	$^\circ\text{C}$
Typical Thermal Resistance Junction to Lead	$T_{STG}$	-65 to 175	$^\circ\text{C}$

#### Notes:

1. Non-repetitive current pulse, per Fig. 3 and derated above  $T_J$  (initial) =  $25^\circ\text{C}$  per Fig. 2.

### Schematic

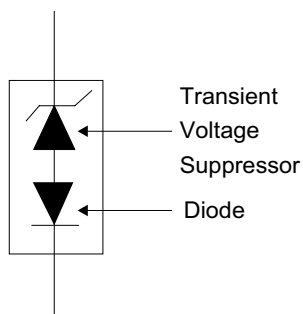

### Description

SMBLCE-HR High Reliability series is designed specifically to protect sensitive electronic equipment from voltage transients induced by lightning and other transient voltage events.

### Features

- For surface mounted applications in order to optimize board space
- Low profile package
- Built-in strain relief
- Typical failure mode is short from over-specified voltage or current
- Whisker test is conducted based on JEDEC JESD201A per its table 4a and 4c
- ESD protection of data lines in accordance with IEC 61000-4-2 ESD 30kV (Air), 30kV (Contact)
- EFT protection of data lines in accordance with IEC 61000-4-4
- Glass passivated chip junction
- Low incremental surge resistance
- 600W peak pulse power capability at 10/1000 $\mu\text{s}$  waveform, repetition rate (duty cycles):0.01 %
- Fast response and excellent clamping capability
- UL Recognized compound meeting flammability rating V-0
- Meet MSL level1, per J-STD-020, high temperature soldering guaranteed:260 $^\circ\text{C}$ /10 seconds at terminals
- Matte tin lead-free plated
- Halogen-Free and RoHS-compliant
- Pb-free E3 means 2nd level interconnect is Pb-free and the terminal finish material is tin(Sn) (IPC/JEDEC J-STD-609A.01)

### Applications

TVS Components are ideal for the protection of I/O Interfaces,  $V_{CC}$  bus and other vulnerable circuits used in Telecom, Computer, Industrial and Consumer electronic applications.



# SMBLCE-HR Series

## Surface Mount - 600W

### Electrical Characteristics

Part Number	Marking Code	Stand-Off Voltage $V_R$ (V)	Minimum Breakdown Voltage $V_{BR}(V)$ @ $I_T$		Test Current $I_T$ (mA)	Maximum Reverse Leakage at $I_R$ @ $V_R$ ( $\mu A$ )	Maximum Clamping Voltage @ $I_{PP}$ $V_C$ (V)	Maximum Peak Pulse Current per (Fig.3) $I_{PP}$ (A)	Maximum Junction Capacitance at 0 Volts $f=1MHz$ (pF)	Working Inverse Blocking Voltage $V_{WIB}$ (V)	Inverse Blocking Leakage Current at $I_{IB}$ @ $V_{WIB}$ (mA)	Peak Inverse Blocking Voltage $V_{PIB}$ (V)	Agency Approval 
			MIN	MAX									
SMBLCE6.5-HR	SKK	6.5	7.22	7.98	10	1000	11.2	53.58	50	75	1.0	100	X
SMBLCE7.0-HR	SKM	7.0	7.78	8.60	10	500	12.0	50.00	50	75	1.0	100	X
SMBLCE7.5-HR	SKP	7.5	8.33	9.21	10	250	12.9	46.52	50	75	1.0	100	X
SMBLCE8.0-HR	SKR	8.0	8.89	9.83	1	100	13.6	44.12	50	75	1.0	100	X
SMBLCE8.5-HR	SKT	8.5	9.44	10.40	1	50	14.4	41.67	50	75	1.0	100	X
SMBLCE9.0-HR	SKV	9.0	10.00	11.10	1	10	15.4	38.97	50	75	1.0	100	X
SMBLCE10-HR	SKX	10.0	11.10	12.30	1	5	17.0	35.30	50	75	1.0	100	X
SMBLCE11-HR	SKZ	11.0	12.20	13.50	1	0.96	18.2	32.97	50	75	1.0	100	X
SMBLCE12-HR	SLE	12.0	13.30	14.70	1	0.96	19.9	30.16	50	75	1.0	100	X
SMBLCE13-HR	SLG	13.0	14.40	15.90	1	0.96	21.5	27.91	50	75	1.0	100	X
SMBLCE14-HR	SLK	14.0	15.60	17.20	1	0.96	23.2	25.87	50	75	1.0	100	X
SMBLCE15-HR	SLM	15.0	16.70	18.50	1	0.96	24.4	24.59	50	75	1.0	100	X
SMBLCE16-HR	SLP	16.0	17.80	19.70	1	0.96	26.0	23.10	50	75	1.0	100	X
SMBLCE17-HR	SLR	17.0	18.90	20.90	1	0.96	27.6	21.74	50	75	1.0	100	X
SMBLCE18-HR	SLT	18.0	20.00	22.10	1	0.96	29.2	20.55	50	75	1.0	100	X
SMBLCE20-HR	SLV	20.0	22.20	24.50	1	0.96	32.4	18.52	50	75	1.0	100	X
SMBLCE22-HR	SLX	22.0	24.40	26.90	1	0.96	35.5	16.91	50	75	1.0	100	X
SMBLCE24-HR	SLZ	24.0	26.70	29.50	1	0.96	38.9	15.43	50	75	1.0	100	X
SMBLCE26-HR	SME	26.0	28.90	31.90	1	0.96	42.1	14.26	50	75	1.0	100	X
SMBLCE28-HR	SMG	28.0	31.10	34.40	1	0.96	45.5	13.19	50	75	1.0	100	X
SMBLCE30-HR	SMK	30.0	33.30	36.80	1	0.96	48.4	12.40	50	75	1.0	100	X
SMBLCE33-HR	SMM	33.0	36.70	40.60	1	0.96	53.3	11.26	50	75	1.0	100	X
SMBLCE36-HR	SMP	36.0	40.00	44.20	1	0.96	58.1	10.33	50	75	1.0	100	X
SMBLCE40-HR	SMR	40.0	44.40	49.10	1	0.96	64.5	9.31	50	75	1.0	100	X
SMBLCE43-HR	SMT	43.0	47.80	52.80	1	0.96	69.4	8.65	50	75	1.0	100	X
SMBLCE45-HR	SMV	45.0	50.00	55.30	1	0.96	72.7	8.26	50	75	1.0	100	X
SMBLCE48-HR	SMX	48.0	53.30	58.90	1	0.96	77.4	7.76	50	75	1.0	100	X
SMBLCE51-HR	SMZ	51.0	56.70	62.70	1	0.96	82.4	7.29	50	75	1.0	100	X
SMBLCE54-HR	SNE	54.0	60.00	66.30	1	0.96	87.1	6.90	50	100	1.0	125	X
SMBLCE58-HR	SNG	58.0	64.40	71.20	1	0.96	93.6	6.42	50	100	1.0	125	X
SMBLCE60-HR	SNK	60.0	66.70	73.70	1	0.96	96.8	6.20	50	100	1.0	125	X
SMBLCE64-HR	SNM	64.0	71.10	78.60	1	0.96	103.0	5.83	50	100	1.0	125	X
SMBLCE70-HR	SNP	70.0	77.80	86.00	1	0.96	113.0	5.31	50	125	1.0	150	X

Note: Each lot of parts will pass group B test requirement.

### Screen Process

<b>100% Vision Inspection</b>	MIL-STD-750 method 2074
<b>100% X-RAY inspection</b>	MIL-STD-750 method 2076
<b>100% Temperature Cycle Test (-55 to 150°C, 20 cycles, dwell time 15 min)</b>	MIL-STD-750 method 1051
<b>100% Reflow (2x)</b>	JEDEC J-STD-020
<b>100% Surge Test (2x)</b>	MIL-STD-750 method 4066
<b>100% HTRB 150°C Bias=<math>V_R</math> (80% breakdown voltage, 96hrs)</b>	MIL-STD-750 method 1038
<b>Final Electrical Test( 100% 3 sigma limit, 100% dynamic test and PAT limit)</b>	MIL-STD-750 method 4016.4021.4011

Note: Up-screen program can be specified by customer's request by contacting Littelfuse customer service

# SMBLCE-HR Series

## Surface Mount - 600W

### Group B Test Requirement

Screen	Method	Condition	Requirement
Surge test	10/1000 $\mu$ s Peak Pulse Waveform	Maximum clamping Voltage ( $V_C$ ) @ Peak Pulse Current ( $I_{PP}$ )	Sample Size 45 perform 10x Accept 0 failures
Burn - In (HTRB)	MIL -STD-750, Method 1038.5	Applied voltage 100% $V_R$ @ 150°C	Sample size 45 340 hours Accept 0 failures
Electrical test	-	$I_R$ @ $V_R$ , $V_{BR}$ @ $I_T$	Sample size 45 Accept 0 failures

### Ratings and Characteristic Curves ( $T_A=25^\circ\text{C}$ unless otherwise noted)

Figure 1 - Peak Pulse Power Rating Curve

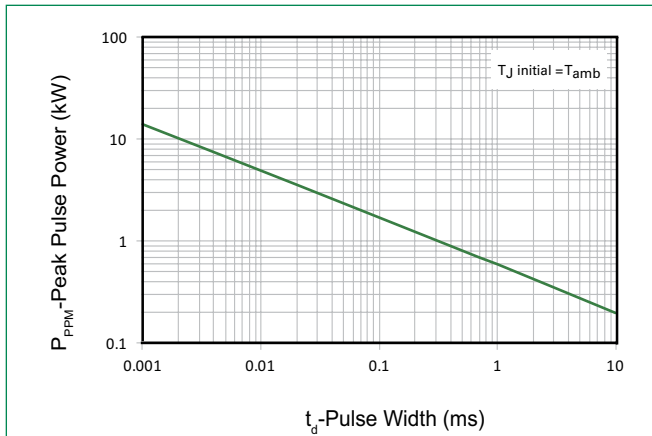

Figure 2 - Peak Pulse Power Derating Curve

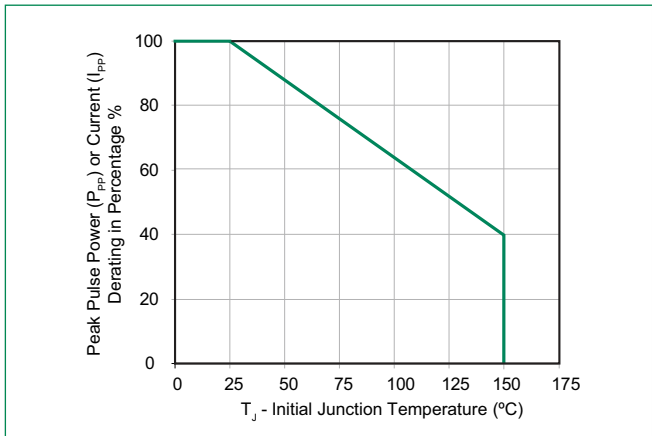

Figure 3 - Pulse Waveform

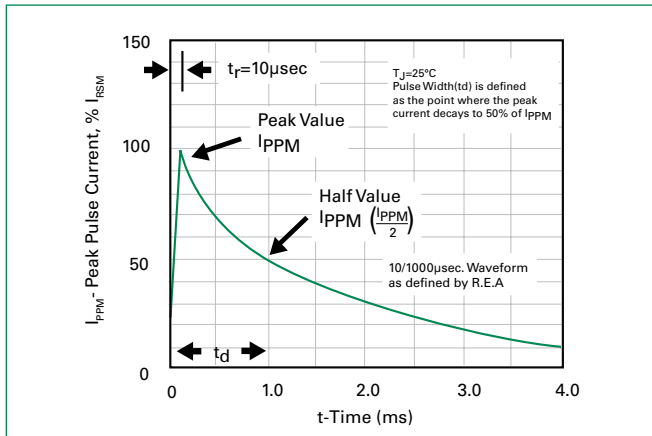
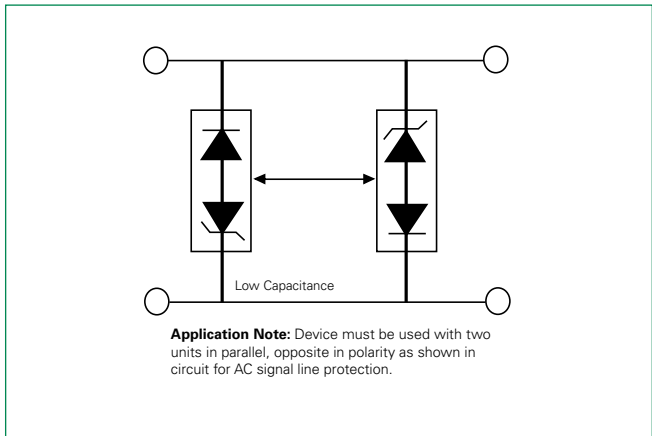

Figure 4 - AC Line Protection Application



# SMBLCE-HR Series

## Surface Mount - 600W

### Soldering Parameters

<b>Reflow Condition</b>		Lead-free assembly
<b>Pre Heat</b>	- Temperature Min ( $T_{s(min)}$ )	150°C
	- Temperature Max ( $T_{s(max)}$ )	200°C
	- Time (min to max) ( $t_s$ )	60 – 180 secs
<b>Average ramp up rate (Liquidus Temp (<math>T_L</math>) to peak)</b>		3°C/second max
<b><math>T_{s(max)}</math> to <math>T_L</math> - Ramp-up Rate</b>		3°C/second max
<b>Reflow</b>	- Temperature ( $T_L$ ) (Liquidus)	217°C
	- Time (min to max) ( $t_s$ )	60 – 150 seconds
<b>Peak Temperature (<math>T_p</math>)</b>		260 <sup>+0/-5</sup> °C
<b>Time within 5°C of actual peak Temperature (<math>t_p</math>)</b>		20 – 40 seconds
<b>Ramp-down Rate</b>		6°C/second max
<b>Time 25°C to peak Temperature (<math>T_p</math>)</b>		8 minutes max.
<b>Do not exceed</b>		260°C

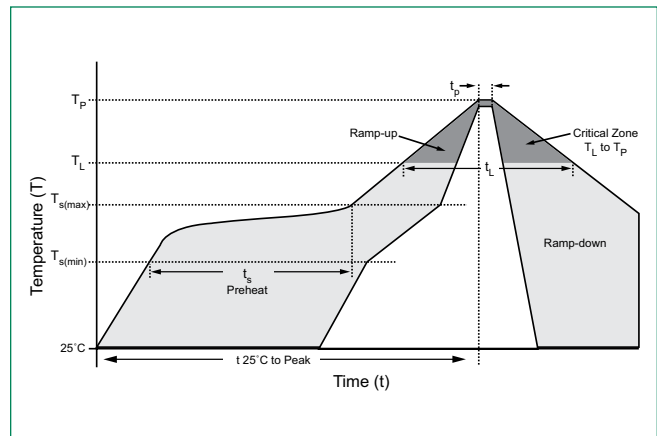

### Physical Specifications

<b>Weight</b>	0.003oz., 0.093g
<b>Case</b>	JEDEC DO-214AA molded plastic body over glass passivated junction.
<b>Polarity</b>	Color band denotes cathode except Bidirectional
<b>Terminal</b>	Matte Tin-plated leads. Solderable per JESD22-B102

### Environmental Specifications

<b>High Temp. Storage</b>	JESD22-A103
<b>HTRB</b>	JESD22-A108
<b>Temperature Cycling</b>	JESD22-A104
<b>MSL</b>	JEDEC-J-STD-020, Level 1
<b>H3TRB</b>	JESD22-A101
<b>RSH</b>	JESD22-A111

### Dimensions

DO-214AA (SMB J-Bend)

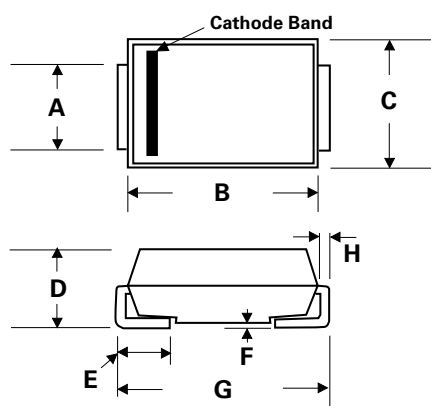

Dimensions	Inches		Millimeters	
	Min	Max	Min	Max
A	0.077	0.086	1.950	2.200
B	0.160	0.180	4.060	4.570
C	0.130	0.155	3.300	3.940
D	0.084	0.096	2.130	2.440
E	0.030	0.060	0.760	1.520
F	-	0.008	-	0.203
G	0.205	0.220	5.210	5.590
H	0.006	0.012	0.152	0.305

# SMBLCE-HR Series

## Surface Mount - 600W

### Part Numbering System

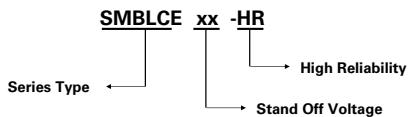

### Part Marking System

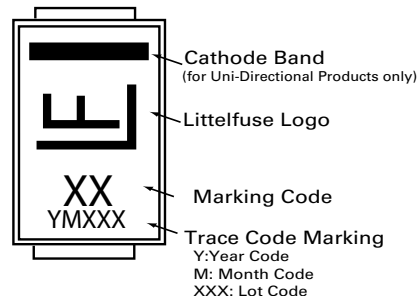

### Packaging

Part number	Component Package	Quantity	Packaging Option	Packaging Specification
SMBLCE-HR	DO-214AA	500	Tape & Reel - 12mm tape/7" reel	EIA STD RS-481

### Tape and Reel Specification

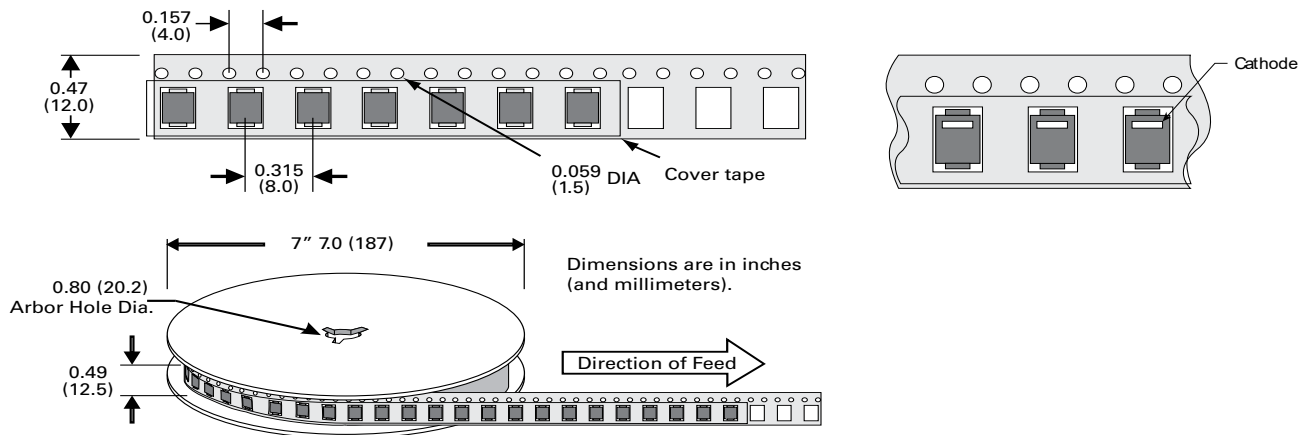

**Disclaimer Notice** - Information furnished is believed to be accurate and reliable. However, users should independently evaluate the suitability of and test each product selected for their own applications. Littelfuse products are not designed for, and may not be used in, all applications. Read complete Disclaimer Notice at <http://www.littelfuse.com/disclaimer-electronics>.